

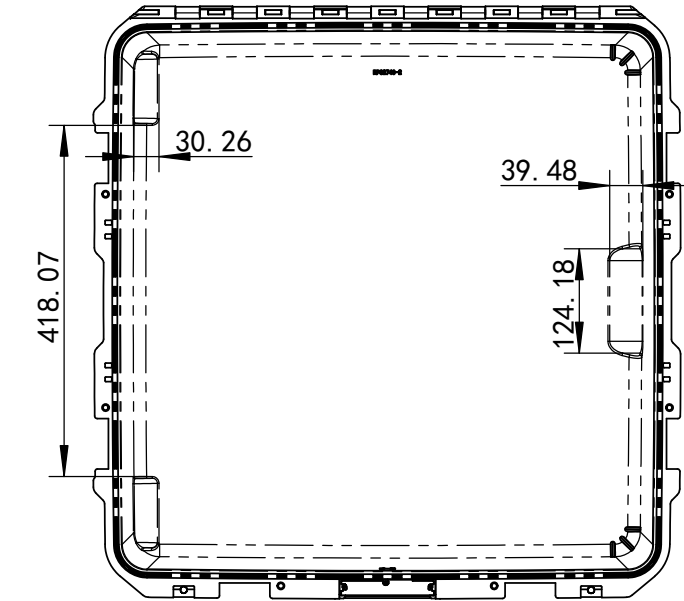

BASIC SIZE	0~3	>3~6	>6~10	>10~18	>18~30	>30~50	>50~80	>80~120	>120~180	>180~250
DIMS TOLERANCE	±0.14	±0.18	±0.22	±0.27	±0.33	±0.39	±0.46	±0.54	±0.63	±0.72

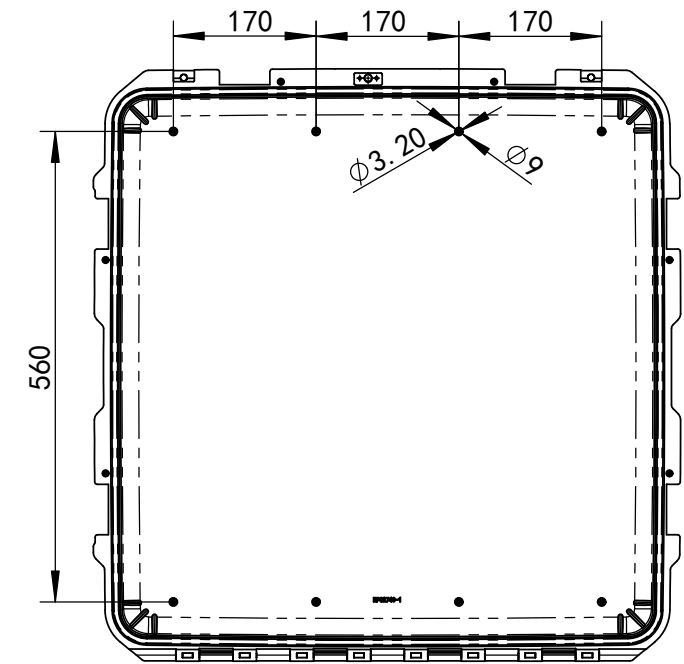
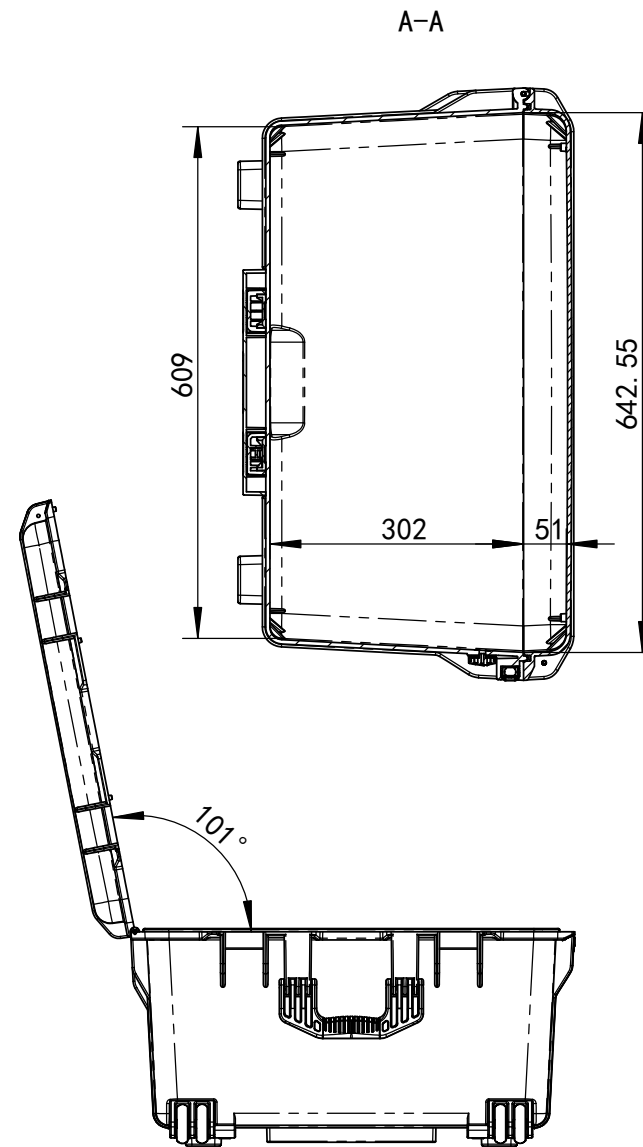
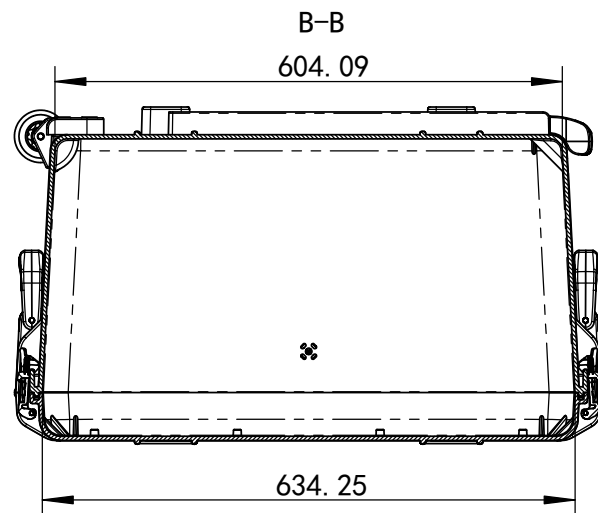
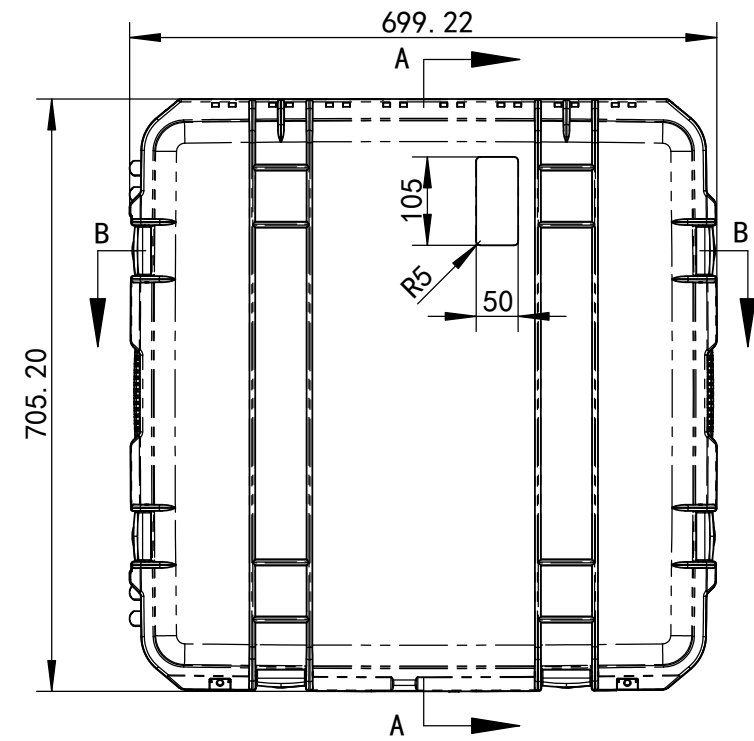
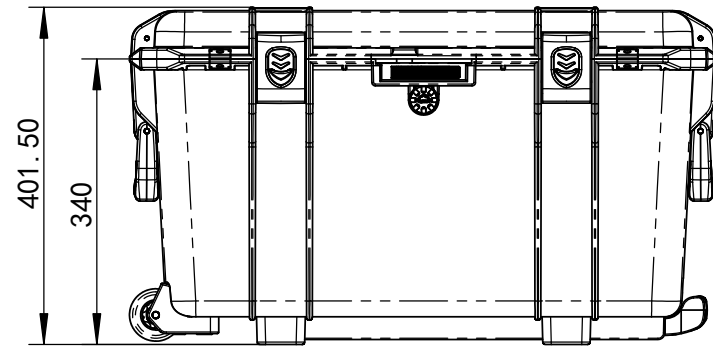
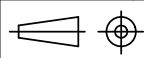

THE MACHINING TOLERANCES		NAME	DATE	 DRX.EVEREST WWW.EVERESTCASE.COM	
UNSPECIFIED TOLERANCES FOLLOW GB/1804-1992 IT13		DRAWN	2017/8/23		
FOAM TOLERANCES		CHECKED		TITLE	RHINO CASE
THE ANGLE TOLERANCES		ENG APPR		MATERIAL	PP
FIRST ANGLE PROJECTION		QT'Y : 1		PART NO	RPC2740
		SCALE	1:1	UNIT	mm
				DO NOT SCALE DRAWING	SHEET OF1 2